

FIBARO KEYFOB FGKF-601

CONTENTS

v1.1

#1: Description and features	3	#8: Activating scenes	11
#2: Basic activation	4	#9: Battery	12
#3: Adding/removing the device	5	#10: Associations	13
#4: Operating the device	6	#11: Advanced parameters	15
#5: Visual indications	7	#12: Specifications	19
#6: Lock Mode	8	#13: Regulations	20
#7: Sequences	10		

Important safety information



Read this manual before attempting to install the device!

Failure to observe recommendations included in this manual may be dangerous or cause a violation of the law. The manufacturer, Fibar Group S.A. will not be held responsible for any loss or damage resulting from not following the instructions of operating manual.

The alarm functionality of devices is an additional feature increasing the comfort level of your home automation system. If you want to use professional security service, please contact them to determine what systems can provide a protection of your estate.

Compliance with safety standards:

The device is designed to be used in Z-Wave home automation systems (e.g. FIBARO) and is complaint with IEC/UL/CSA 60950-1. In case of the integration with another system, e.g. alarm system, it is required to verify the compliance with additional standards.

General information about the FIBARO System

FIBARO is a wireless smart home automation system, based on the Z-Wave protocol. All of available devices can be controlled through a computer (PC or Mac), smartphone or tablet. Z-Wave devices are not only receivers, but can also repeat the signal, increasing the Z-Wave network's range. It gives advantage over traditional wireless systems that require direct link between transmitter and receiver, as a result the construction of the building could affect network's range negatively.

Every Z-Wave network has its unique identification number (home ID). Multiple independent networks can exist in the building without interfering. Transmission security of FIBARO System is comparable to wired systems.

Z-Wave technology is the leading solution in smart home automation. There is a wide range of Z-Wave devices that are mutually compatible, independently of manufacturer. It gives the system the ability to evolve and expand over time. For more information visit www.fibaro.com.

#1: Description and features

FIBARO KeyFob is a Z-Wave Plus compatible, battery-powered, compact remote control.

Six buttons allow you to control other devices through the Z-Wave network and run various scenes defined in FIBARO System.

Configure actions for one, two, three clicks, holding the button and button sequences to suit all your needs.

Built-in locking system will ensure that unauthorized person will not take control of your home.

Main features of FIBARO KeyFob:

- Compatible with any Z-Wave or Z-Wave Plus Controller,
- Supports Z-Wave network Security Mode with AES-128 encryption,
- Battery powered,
- Completely wireless,
- Pocket size,
- Equipped with 6 easily recognizable buttons,
- 30 different actions, single/double/triple click, hold for each button and sequences,
- Easy to operate menu,
- Actions are confirmed by the built-in LED diode.



FIBARO KeyFob is a fully compatible Z-Wave Plus device.

i NOTE

This device may be used with all devices certified with the Z-Wave Plus certificate and should be compatible with such devices produced by other manufacturers.

i NOTE

Z-Wave Controller must support Z-Wave Security Mode in order to fully utilize the product.

#2: Basic activation

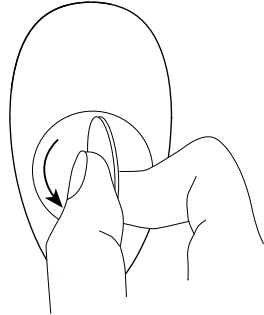

1. Using included keyring or a coin, open the battery cover by turning it counter-clockwise.

2. Remove the sticker protecting the battery.

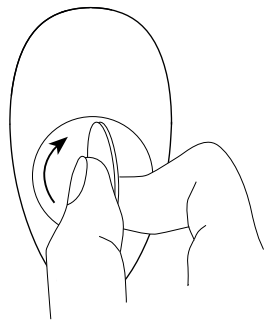

3. Using included keyring or a coin, close the battery cover by turning it clockwise.

4. Locate the device nearby the main Z-Wave controller.
5. Set the main Z-Wave controller in (Security/non-Security Mode) add mode (see the controller's manual).
6. Click any button three times.
7. LED will pulse white during the adding process.
8. Wait for the device to be added into the system.
9. Successful adding will be confirmed by the Z-Wave controller's message and green LED colour.

#3: Adding/removing the device

Adding (Inclusion) - Z-Wave device learning mode, allowing to add the device to existing Z-Wave network.

To add the device:

1. Set the main Z-Wave controller in (Security/non-Security Mode) add mode (see the controller's manual).
2. Power the device (insert the battery).
3. Click any button three times.
4. LED will pulse white during the adding process.
5. Wait for the adding process to end.
6. Successful adding will be confirmed by the Z-Wave controller's message and green LED colour.

Removing (Exclusion) - Z-Wave device learning mode, allowing to remove the device from existing Z-Wave network.

To remove the device:

1. Set the main Z-Wave controller in remove mode (see the controller's manual).
2. Click **○** and **—** simultaneously.
3. Click **▲** or **✕** until LED glows green.
4. Click **+**.
5. Wait for the removing process to end.
6. Successful removing will be confirmed by the Z-Wave controller's message.

NOTE

Adding in Security Mode must be performed up to 2 meters from the controller.

NOTE

In case the device is not added, please reset the device and repeat the adding procedure.

NOTE

Removing the KeyFob from the Z-Wave network restores all the default parameters of the device.

#4: Operating the device

Menu allows to perform Z-Wave network actions. In order to use the menu:

1. Click **○** and **—** simultaneously.
2. Click **▲** or **✕** until LED indicates desired menu position with colour:
 - **White** - wake up the device
 - **Green** - learning mode (adding/removing)
 - **Cyan** - check battery level
 - **Yellow** - reset the device*
3. Click **+** to confirm selection, Click **—** to exit the menu.
4. LED will pulse twice with same colour as selected menu position to confirm completing action.

i NOTE

* Resetting the device from the menu is not available in Lock Mode.

Waking up the device:

The KeyFob needs to be woken up to receive information about the new configuration from the Z-Wave controller, like parameters and associations. Use 1st menu position (white) or click **○** and **+** simultaneously to wake up the device.

i NOTE

Resetting the device is not the recommended way of removing the device from the Z-Wave network. Use the reset procedure only if the primary controller is missing or inoperable. Certain device removal can be achieved by the procedure of removing described in "Adding/removing the device" on page 5.

Resetting the device to factory defaults:

Reset procedure allows to restore the device back to its factory settings, which means all information about the Z-Wave controller and user configuration will be deleted. There are two ways of resetting the device:

Resetting the device **using the menu:**

1. Click **○** and **—** simultaneously.
2. Click **▲** or **✕** until LED glows yellow.
3. Click **+**.

Emergency resetting the device **on start-up:**

1. Remove the battery.
2. Hold **□** and **+**, while inserting the battery.

Successful resetting will be confirmed by smoothly brightening and dimming of the yellow LED colour.

#5: Visual indications

Visual indications:

The KeyFob is equipped with a LED diode, signalling pushing the buttons, sequences, menu position and status of the device.

Indications for scenes and associations:

After pressing one of the buttons or using sequence, KeyFob indicates status of action with the LED diode.

What you see	What it means
Green blink	Receiving command confirmed by the controller and associated devices
Yellow blink every 1s	Sending commands in progress
Red blink	Receiving at least one command was not confirmed by the controller or associated devices

Indications for sequences:

What you see	What it means
Blue pulse	Entering sequence
3 blue pulses	Sequence valid
3 red pulses	Sequence not valid

Device status indications:

What you see	What it means	What to do
Learning mode		
Red blink	Device not added	Click any button three times to start adding
Fast white pulsing	Device in adding mode	Wait for adding process to end
Green blink	Device added	–
Lock Mode		
Red blink	Device locked	Unlock using sequence
3 red pulses	Wrong sequence	Try unlocking again
Red to green transition	Device unlocked	Press buttons to activate scenes/associations
Green to red transition	Device locked using button hold	–
Battery		
3 magenta pulses	Low battery	Replace the battery
Configuration		
2 white pulses	Device woken up	–

#6: Lock Mode

The KeyFob can be protected with a sequence of 2 to 5 button clicks. When unlocking sequence is set, the device will lock itself after:

- being inactive for time set in parameter 2 (60 seconds by default),
- pressing and holding selected button (if set in parameter 2).

To enable Lock Mode:

- set sequence in parameter 1,
- set time and/or locking button in parameter 2 (60 seconds by default),
- set PROTECTION Command Class to Local Protection by Sequence (done automatically by Home Center controller).

Lock Mode will be disabled when:

- parameter 1 and/or parameter 2 is set to 0,
- PROTECTION Command Class is set to Unprotected.

When device is locked:

- pushing buttons will not activate any actions,
- menu is available, but without option of resetting the device.

Setting the unlocking sequence and locking time-out using Home Center configuration interface:

1. Go to the device options by clicking the icon: 
2. Select the „Advanced“ tab.
3. Click the “Configure” button in "Lock Mode" section.
4. Select sequence of 2 to 5 buttons, click "Next".
5. Select time to lock and locking button, click "Next".
6. Click **○** and **+** simultaneously to wake up the device.
7. Wait for the device to configure.

Setting the unlocking sequence using advanced parameter:

1. Calculate value of parameter using table and formula:

Button	□	○	×	△	-	+
Value	1	2	3	4	5	6

Value of parameter = Value of first button +
 + 8 * Value of second button + 64 * Value of third button +
 + 512 * Value of fourth button + 4096 * Value of fifth button

2. Change the value of parameter 1 [2 bytes] to calculated value.
3. Click ○ and + simultaneously to wake up the device.
4. Wait for the device to configure.

Setting time to lock and locking button using advanced parameter:

1. Calculate value of parameter using table and formula:

Button	□	○	×	△	-	+
Value	1	2	3	4	5	6

Time to lock should be 0 or 5-255 (seconds)

Value of parameter = Time to lock in seconds +
 + 256 * Value of locking button

2. Change the value of parameter 2 [2 bytes] to calculated value.
3. Click ○ and + simultaneously to wake up the device.
4. Wait for the device to configure.

#7: Sequences

Sequences:

User can create sequences of two to five button to expand number of possible actions. Every sequence sends corresponding Scene ID to the Z-Wave controller with attribute "Key pressed 1 time" (see "Scene activation" on page 11).

Sequences are saved in advanced parameters (no. 3-8).

Activating sequence introduces delay in single, double and triple click actions for first button in the sequence.

Rules of creating sequences:

- Maximum of six sequences can be created.
- Each sequence must be unique.
- Sequence can consist of two to five button pushes.
- Sequence can contain multiple clicks of the same button.

Setting a new sequence using advanced parameter:

1. Calculate value of parameter using table and formula:

Button	□	○	×	△	—	+
Value	1	2	3	4	5	6

Value of parameter = Value of first button +
 + 8 * Value of second button + 64 * Value of third button +
 + 512 * Value of fourth button + 4096 * Value of fifth button

2. Change the value of corresponding parameter [2 bytes] (parameters 3 to 8 for slots 1 to 6).
3. Click ○ and + simultaneously to wake up the device.
4. Wait for the device to configure.

#8: Activating scenes

Activating scenes:

The KeyFob can activate scenes in the Z-Wave controller by sending scene ID and attribute of a specific action using Central Scene Command Class.

By default scenes are activated after single clicking or pressing and holding any of the buttons and sequences. Other actions can be activated in parameters 21-26.

Activating a double click will introduce delay to a single click reaction and activating a triple click will introduce delay to a double click reaction.

Scene IDs of buttons:

Button	□	○	×	△	—	+
Scene ID	1	2	3	4	5	6

Scene IDs of sequences:

Sequence number	1	2	3	4	5	6
Scene ID	7	8	9	10	11	12

Attributes of actions:

Action	Attribute
Button clicked once	Key Pressed 1 time
Button clicked twice	Key Pressed 2 times
Button clicked thrice	Key Pressed 3 times
Button held	Key Held Down
Button released	Key Released
Sequence performed	Key Pressed 1 time

#9: Battery

CAUTION

Using batteries other than specified may result in explosion. Dispose of properly, observing environmental protection rules.

NOTE

Battery life depends on frequency of usage, number of associations/scenes, Z-Wave routing and network load.

The KeyFob can be powered with CR2450 (included) battery. Estimated battery life with device added once, default settings, direct range and maximum 5 pushes per day is 2 years.

Checking battery level:

KeyFob automatically warns about low battery with 3 magenta blinks.

1. Click **○** and **—** simultaneously.
2. Click **▲** or **✕** until LED glows cyan.
3. Click **+**.
4. LED indicates battery level with a smoothly transitioning colours, where:
 - Green - 100%
 - Yellow - 50%
 - Red - 1%
5. Wait 2 second or click any button to exit.

Replacing the battery:

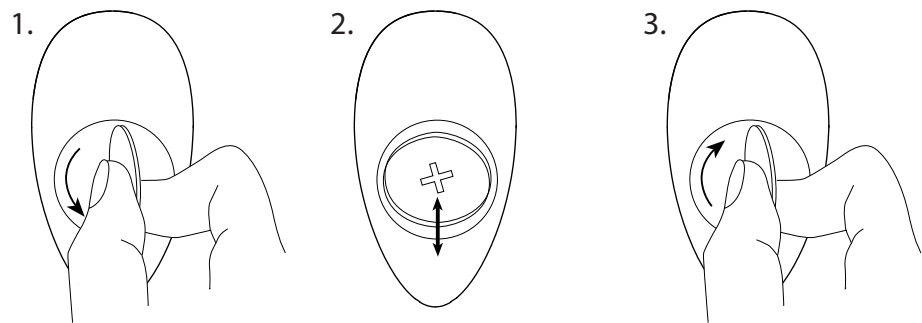

1. Using included keyring or a coin, open the battery cover by turning it counter-clockwise.
2. Replace the battery.
3. Using included keyring or a coin, close the battery cover by turning it clockwise.

#10: Associations

Association (linking devices) - direct control of other devices within the Z-Wave system network e.g. Dimmer, Relay Switch, Roller Shutter or scene (may be controlled only through a Z-Wave controller).

The device provides the association of thirteen groups:

1st association group – “Lifeline” reports the device status and allows for assigning single device only (main controller by default).

2nd association group – “Square - On/Off” is assigned to clicking the  button and is used to turn on/off associated devices.

3rd association group – “Square - Multilevel” is assigned to clicking and holding the  button and is used to turn on/off and change level of associated devices.

4th association group – “Circle - On/Off” is assigned to clicking the  button and is used to turn on/off associated devices.

5th association group – “Circle - Multilevel” is assigned to clicking and holding the  button and is used to turn on/off and change level of associated devices.

6th association group – “Cross - On/Off” is assigned to clicking the  button and is used to turn on/off associated devices.

7th association group – “Cross - Multilevel” is assigned to clicking and holding the  button and is used to turn on/off and change level of associated devices.

8th association group – “Triangle - On/Off” is assigned to clicking the  button and is used to turn on/off associated devices.

9th association group – “Triangle - Multilevel” is assigned to clicking and holding the  button and is used to turn on/off and change level of associated devices.

10th association group – “Minus - On/Off” is assigned to clicking the  button and is used to turn on/off associated devices.

11th association group – “Minus - Multilevel” is assigned to clicking and holding the  button and is used to turn on/off and change level of associated devices.

12th association group – “Plus - On/Off” is assigned to clicking the  button and is used to turn on/off associated devices.

13th association group – “Plus - Multilevel” is assigned to clicking and holding the  button and is used to turn on/off and change level of associated devices.

NOTE

Association ensures direct transfer of control commands between devices, is performed without participation of the main controller and requires associated device to be in the direct range.

NOTE

States of the association groups are affected only by buttons. Changing state of associated device by other means will not update remembered state of association group.

NOTE

2, 4, 6, 8, 10 and 12 association groups use BASIC CC, but device does not respond to GET commands.

The KeyFob in 2nd to 13th group allows to control 5 devices (regular or multichannel) per an association group. "LifeLine" group is reserved solely for the controller and hence only 1 node can be assigned.

It is not recommended to associate more than 10 devices in general, as the response time to control commands depends on the number of associated devices. In extreme cases, system response may be delayed.

To add an association (using the Home Center controller):

1. Go to the device options by clicking the icon: 
2. Select the „Advanced" tab.
3. Click the "Setting Association" button.
4. Specify to which group and what devices are to be associated.
5. Save the changes.
6. Click **○** and **+** simultaneously to wake up the device.

Paired buttons associations

After pairing buttons, horizontal pairs of buttons (**□** and **○**, **×** and **△**, **–** and **+**) work as one button and send associations to left buttons groups only.

Left buttons (**□**, **×**, **–**) turn on associated devices and right buttons (**○**, **△**, **+**) turn them off.

In multilevel association groups (3, 7, 11) left buttons increase level while holding and right buttons decrease it.

To pair buttons:

1. Change settings of parameters:
 - **□** and **○** – set parameter 6 to value 1
 - **×** and **△** – set parameter 7 to value 1
 - **–** and **+** – set parameter 8 to value 1
2. Save the changes.
3. Click **○** and **+** simultaneously to wake up the device.

#11: Advanced parameters

The KeyFob allows to customize its operation to user's needs. The settings are available in the FIBARO interface as simple options that may be chosen by selecting the appropriate box.

In order to configure the KeyFob (using the Home Center controller):

1. Go to the device options by clicking the icon: 
2. Select the „Advanced” tab.
3. Modify values of chosen parameters.
4. Save the changes.
5. Click **O** and **+** simultaneously to wake up the device.

1. Lock Mode - unlocking sequence

This parameter allows to activate Lock Mode and set up unlocking sequence. Device will lock after time set in parameter 2 or after pressing and holding selected button. See "Lock Mode" on page 9 for more information.

Available settings:	0 - Lock Mode disabled 9-28086 - unlocking sequence		
Default setting:	0	Parameter size:	2 [bytes]

2. Lock Mode - time to lock and locking button

This parameter allows to set time that must elapse from the last press of the button to lock the device and locking button.

Setting locking button will deactivate associations and scenes for pressing and holding the selected button.

This parameter is irrelevant if parameter 1 is set to 0 (Lock Mode disable).

See "Lock Mode" on page 9 for more information.

Available settings:	0 - Lock Mode disabled 5-1791 - calculated value		
Default setting:	60 (60s)	Parameter size:	2 [bytes]

3. First scene sequence

This parameter allows to set up sequence that activates scene with ID 7. See "Sequences" on page 10 for more information.

Available settings:	0 - 1st sequence disabled 9-28086 - value of sequence		
Default setting:	0	Parameter size:	2 [bytes]

NOTE

Entering invalid value of parameter will result in response with Application Rejected frame and not setting the value.

4. Second scene sequence

This parameter allows to set up sequence that activates scene with ID 8. See "Sequences" on page 10 for more information.

Available settings:	0 - 2nd sequence disabled 9-28086 - value of sequence		
Default setting:	0	Parameter size:	2 [bytes]

5. Third scene sequence

This parameter allows to set up sequence that activates scene with ID 9. See "Sequences" on page 10 for more information.

Available settings:	0 - 3rd sequence disabled 9-28086 - value of sequence		
Default setting:	0	Parameter size:	2 [bytes]

6. Fourth scene sequence

This parameter allows to set up sequence that activates scene with ID 10. See "Sequences" on page 10 for more information.

Available settings:	0 - 4th sequence disabled 9-28086 - value of sequence		
Default setting:	0	Parameter size:	2 [bytes]

7. Fifth scene sequence

This parameter allows to set up sequence that activates scene with ID 11. See "Sequences" on page 10 for more information.

Available settings:	0 - 5th sequence disabled 9-28086 - value of sequence		
Default setting:	0	Parameter size:	2 [bytes]

8. Sixth scene sequence

This parameter allows to set up sequence that activates scene with ID 12. See "Sequences" on page 10 for more information.

Available settings:	0 - 6th sequence disabled 9-28086 - value of sequence		
Default setting:	0	Parameter size:	2 [bytes]

9. Sequences - timeout

This parameter allows to set time that must elapse from the last click of the button to check if the sequence is valid.

Available settings:	5-30 (0.5-3s, 0.1s step) - time to lock		
Default setting:	10 (1s)	Parameter size:	1 [byte]

10. Single button associations - operating mode

This parameter allows to choose operating mode for single button associations.

Available settings:	0 - single click switches state to opposite 1 - single click switches state to opposite, double click sets to maximum level 2 - single click turns on, double click turns off		
Default setting:	0 (switch)	Parameter size:	1 [byte]

11. Value sent to □ association groups

12. Value sent to ○ association groups

13. Value sent to ✕ association groups

14. Value sent to ▲ association groups

15. Value sent to – association groups

16. Value sent to + association groups

This parameter allows to set value sent to devices in association group. It will result in turning multilevel devices on with set or last level. Value is irrelevant for simple on/off devices.

Available settings:	1-99 or 255		
Default setting:	255	Parameter size:	2 [bytes]

17. Paired buttons association for □ and ○

This parameter allows to activate paired buttons association mode for □ and ○ buttons. Paired buttons are dependent and association are sent only to □ groups. ○ turns devices on and increases value, □ turns them off and decreases value.

Available settings:	0 - paired buttons association inactive 1 - paired buttons association active		
Default setting:	0 (inactive)	Parameter size:	1 [byte]

18. Paired buttons association for ✕ and ▲

This parameter allows to activate paired buttons association mode for ✕ and ▲ buttons. Paired buttons are dependent and association are sent only to ✕ groups. ▲ turns devices on and increases value, ✕ turns them off and decreases value.

Available settings:	0 - paired buttons association inactive 1 - paired buttons association active		
Default setting:	0 (inactive)	Parameter size:	1 [byte]

i NOTE

Setting parameters 11-16 to appropriate value will result in:

1-99 - forcing level of associated devices

255 - setting associated devices to the last remembered state or turning them on

19. Paired buttons association for – and +

This parameter allows to activate paired buttons association mode for – and + buttons. Paired buttons are dependent and association are sent only to – groups. + turns devices on and increases value, – turns them off and decreases value.

Available settings:	0 - paired buttons association inactive 1 - paired buttons association active		
Default setting:	0 (inactive)	Parameter size:	1 [byte]

21. Scene activation for □ button

22. Scene activation for O button

23. Scene activation for X button

24. Scene activation for Δ button

25. Scene activation for – button

26. Scene activation for + button

This parameter determines which actions result in sending assigned scene IDs and attributes to the controller.

Available settings:	1 - Key Pressed 1 time 2 - Key Pressed 2 times 4 - Key Pressed 3 times 8 - Key Held Down & Released		
Default setting:	9 (1x & hold)	Parameter size:	1 [byte]

29. Associations in Z-Wave network Security Mode

Parameter defines how commands are sent in specified association groups: using Security Mode or not. Parameter is active only in Z-Wave network Security Mode. It does not apply to 1st "Lifeline" association group.

Available settings:	1 - 2nd group sent using Security Mode 2 - 3rd group sent using Security Mode 4 - 4th group sent using Security Mode 8 - 5th group sent using Security Mode 16 - 6th group sent using Security Mode 32 - 7th group sent using Security Mode 64 - 8th group sent using Security Mode 128 - 9th group sent using Security Mode 256 - 10th group sent using Security Mode 512 - 11th group sent using Security Mode 1024 - 12th group sent using Security Mode 2048 - 13th group sent using Security Mode		
Default setting:	4095	Parameter size:	2 [bytes]

i NOTE

Parameters 21 to 26 values may be combined, e.g. 1+2=3 means that clicking button once or twice will result in sending assigned scene ID.

i NOTE

Parameter 29 values may be combined, e.g. 1+2=3 means that 2nd & 3rd group are sent using Security Mode.

#12: Specifications

Power supply:	CR2450 3.0V battery (included)
Battery life:	est. 2 years (default settings, max. 5 pushes per day and direct range)
Operating temperature:	10 - 40°C
Protection class:	IP54
EU directives compliance:	RoHS 2011/65/EU RoHS 2015/863 RED 2014/53/EU
Radio protocol:	Z-Wave (500 series chip)
Radio frequency:	868.4, 868.42 or 869.8 MHz EU; 908.4, 908.42 or 916.0 MHz US; 921.4, 921.42 or 919.8 MHz ANZ; 869.0 or 869.02 MHz RU;
Range:	up to 50m outdoors up to 40m indoors (Depending on terrain and building structure)
Dimensions:	70 x 38 x 15 mm

CAUTION

Using batteries other than specified may result in explosion. Dispose of properly, observing environmental protection rules.

NOTE

Battery life depends on frequency of usage, number of associations/scenes, Z-Wave routing and network load.

NOTE

Radio frequency of individual device must be same as your Z-Wave controller. Check information on the box or consult your dealer if you are not sure.

#13: Regulations

This device complies with Part 15 of the FCC Rules

Operation is subject to the following two conditions:

1. This device may not cause harmful interference
2. This device must accept any interference received, including interference that may cause undesired operation. This equipment has been tested and found to comply with the limits for a Class B digital device, pursuant to part 15 of the FCC Rules. These limits are designed to provide reasonable protection against harmful interference in a residential installation. This equipment generates, uses and can radiate radio frequency energy and, if not installed and used in accordance with the instructions, may cause harmful interference to radio communications. However, there is no guarantee that interference will not occur in a particular installation. If this equipment does cause harmful interference to radio or television reception, which can be determined by turning the equipment off and on, the user is encouraged to try to correct the interference by one or more of the following measures:

- Reorient or relocate the receiving antenna.
- Increase the separation between the equipment and receiver.
- Connect the equipment into an outlet on a circuit different from that to which the receiver is connected.
- Consult the dealer or an experienced radio/TV technician for help.

Changes and modifications not expressly approved by the manufacturer or registrant of this equipment can void your authority to operate this equipment under Federal Communications Commission's rules.

Industry Canada (IC) Compliance Notice

This device complies with Industry Canada license-exempt RSSs. Operation is subject to the following two conditions: (1) this device may not cause interference, and (2) this device must accept any interference, including interference that may cause undesired operation of the device.

Cet appareil est conforme aux normes d'exemption de licence RSS d'Industry Canada. Son fonctionnement est soumis aux deux conditions suivantes : (1) cet appareil ne doit pas causer d'interférence et (2) cet appareil doit accepter toute interférence, notamment les interférences qui peuvent affecter son fonctionnement.

Legal Notices

All information, including, but not limited to, information regarding the features, functionality, and/or other product specification are subject to change without notice. Fibaro reserves all rights to revise or update its products, software, or documentation without any obligation to notify any individual or entity.

FIBARO and Fibar Group logo are trademarks of Fibar Group S.A. All other brands and product names referred to herein are trademarks of their respective holders.

Product is covered by one or more claims of patents found at <http://sipcollc.com/patent-list/> and <http://intusiq.com/patent-list/>.

DGT Warning Statement

Article 12

Without permission, any company, firm or user shall not alter the frequency, increase the power, or change the characteristics and functions of the original design of the certified lower power frequency electric machinery.

Article 14

The application of low power frequency electric machineries shall not affect the navigation safety nor interfere a legal communication, if an interference is found, the service will be suspended until improvement is made and the interference no longer exists.

第十二條

經型式認證合格之低功率射頻電機，非經許可，公司、商號或使用者均不得擅自變更頻率、加大功率或變更原設計之特性及功能。

第十四條

低功率射頻電機之使用不得影響飛航安全及干擾合法通信；經發現有干擾現象時，應立即停用，並改善至無干擾時方得繼續使用。前項合法通信，指依電信法規定作業之無線電通信。

低功率射頻電機須忍受合法通信或工業、科學及醫療用電波輻射性電機設備之干擾。

Warning

This product is not a toy. Keep away from children and animals!

Declaration of conformity

 Hereby, Fibar Group S.A. declares that the device is in compliance with the essential requirements and other relevant provisions of Directives 2014/53/EU. The full text of the EU declaration of conformity is available at the following internet address: www.manuals.fibaro.com

WEEE Directive Compliance



Device labelled with this symbol should not be disposed with other household wastes. It shall be handed over to the applicable collection point for the recycling of waste electrical and electronic equipment.

